

03

0314-1

Circular connectors with threaded joint M16 acc. to IEC 61076-2-106, IP40/IP68



Chassis plug acc. to AISG specification and IEC 61076-2-106, IP68, with threaded joint and solder terminals, for front mounting

03 0314-1

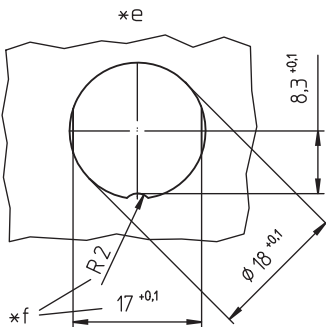
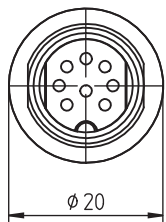
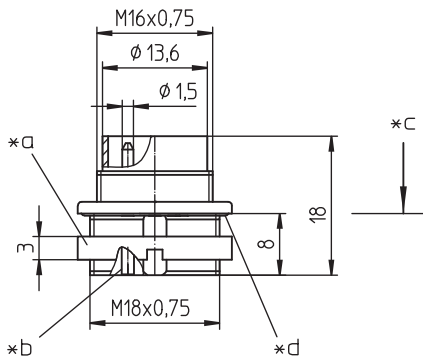
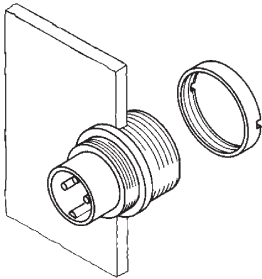

Environmental conditions

Temperature range -40 °C/+85 °C

Materials

Insulating body	PA GF, V-0 according to UL94
Contact pin	CuZn, silver-plated and flash gold-plated
Housing	Zn diecast, pre-copper and nickel-plated
Ring screw	CuZn, nickel-plated
Seal	NBR

Mechanical data

Tightening torque connector	1-3 Nm
Tightening torque nut	1-3 Nm
Protection class	IP68 ¹

¹ according to IEC DIN EN 60529, only in locked condition with an appropriate counterpart; IPX8 requirements under agreement between manufacturer and user









Connectable conductors for solder area







Section $\leq 0.75 \text{ mm}^2$ (AWG 20)

Electrical data (at $T_{\text{amb}} 20 \text{ °C}$)

Rated current	5 A ($T_{\text{amb}} 40 \text{ °C}$)
Rated voltage	100 V (with pollution degree 1) 32 V (with pollution degree 2)
Rated impulse voltage	500 V
Material group	II (IEC)/I (UL) ($400 \leq \text{CTI} < 600$)
Overvoltage category	I
Insulation resistance	$> 100 \text{ M}\Omega$

Associated products

Counterparts		
 0321	 0322	 0322-1
 032200	 0360	 036000
 Weitere Produkte auf Anfrage	 Weitere Produkte auf Anfrage	

Accessories		
 0382	 0383	 038399
 0384	 0385	 038899

03

0314-1

Pin configurations, solder side view

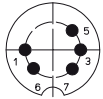

*g

0314-1 05-3

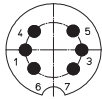

0314-1 06-1

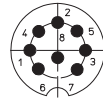

08-a

0314-1 08-1

- *a nut enclosed separately
- *b cup-shaped solder terminal
- *c mounting direction
- *d O-ring gasket
- *e port in mounting plate
- *f anti-rotation, alternative execution
- *g pin configuration according to AISG C485

03

0314-1

Designation	Pole Number	PU (Pieces)	MDQ (Pieces)
0314-1 05-3	5	50	100
0314-1 08-1	8	50	100

Packaging:

in a cardboard box