

03 SFV

Circular connectors with threaded joint M16 acc. to IEC 61076-2-106, IP40/IP68



Chassis plug acc. to IEC 61076-2-106, IP40, with threaded joint and solder terminals, for front mounting

03 SFV

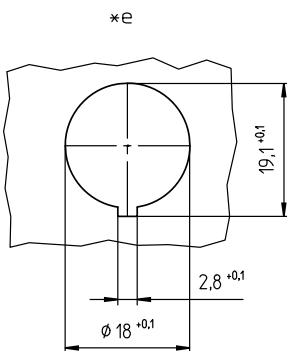
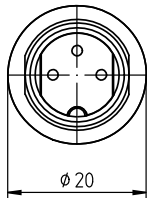
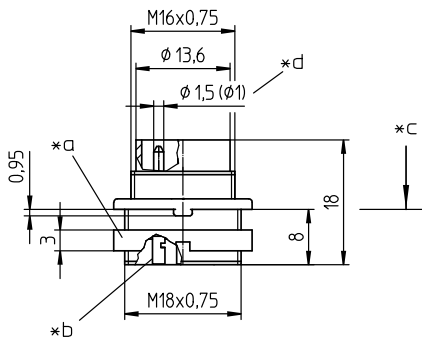
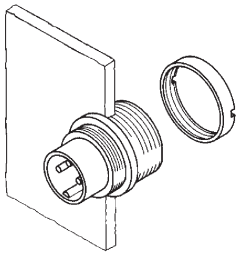

Environmental conditions

Temperature range -40 °C/+85 °C

Materials

Insulating body PA GF, V-0 according to UL94
 Contact pin CuZn, silver-plated and flash gold-plated (3-8 poles)
 CuZn, pre-nickel and gold-plated (12 poles)
 Housing Zn diecast, pre-copper and nickel-plated
 Ring screw CuZn, nickel-plated

Mechanical data

Tightening torque connector 1-3 Nm
 Tightening torque nut 1-3 Nm
 Protection class IP40¹

¹ according to IEC DIN EN 60529, only in locked condition with an appropriate counterpart

Connectable conductors for solder area

Section $\leq 0,75 \text{ mm}^2$ (AWG 20) (3-8 poles)
 $\leq 0,25 \text{ mm}^2$ (AWG 24) (12 poles)

Electrical data (at T_{amb} 20 °C)

Rated current 5 A (T_{amb} 40 °C, 3-8 poles)
 3 A (T_{amb} 40 °C, 12 poles)
 Rated voltage with pollution degree 1:
 300 V (versions 30, 40, 50/6, 60, 70)
 100 V (versions 50, 71, 80, 81)
 160 V (Polbild 120)
 with pollution degree 2:
 250 V (versions 30, 40)
 32 V (versions 50, 71, 80, 81)
 160 V (versions 50/6, 60, 70, 120)
 Rated impulse voltage 1500 V (versions 30, 40, 50/6, 60, 70, 120)
 500 V (versions 50, 71, 80, 81)
 Material group II (IEC)/I (UL) (400 \leq CTI < 600)
 Overvoltage category I
 Insulation resistance > 100 M Ω

03 SFV

Pin configurations, solder side view

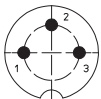

03-a
SFV 30



04-a
SFV 40

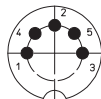

05-b
SFV 50

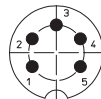

05-a
SFV 50/6

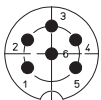

06-a
SFV 60

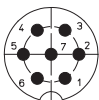

07-a
SFV 70

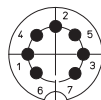

07-b
SFV 71

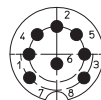

SFV 80

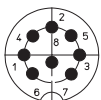

08-a
SFV 81

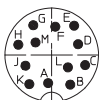

12-a
SFV 120

- *a nut enclosed separately
- *b cup-shaped solder terminal
- *c mounting direction
- *d 12 pole version Ø 1.0 mm
- *e port in mounting plate

Associated products

Counterparts

- | | | |
|----------------------------|----------------------------|--------------------------|
| KV | KV ... C | KV ...-8 |
| KV ...-8 C | KV ...-8 C | WKV |
| WKV ... C | | |

Accessories

- | | | |
|----------------------|----------------------|------------------------|
| 0382 | 0383 | 038399 |
| 0384 | 0385 | 038899 |

Harnessing equipment

- [ZMS 20](#)

03

SFV

Designation	Pole Number	PU (Pieces)	MDQ (Pieces)
SFV 30	3	50	100
SFV 40	4	50	100
SFV 50	5	50	100
SFV 50/6	5	50	100
SFV 60	6	50	100
SFV 70	7	50	100
SFV 71	7	50	100
SFV 80	8	50	100
SFV 81	8	50	100
SFV 120	12	50	100

Packaging:

in a cardboard box